

Rotator hidraulic CR 600 FX

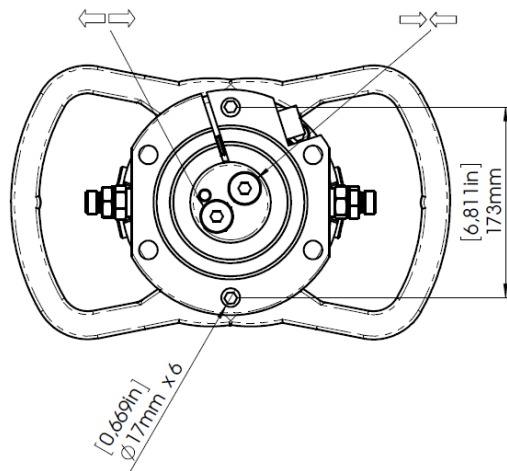
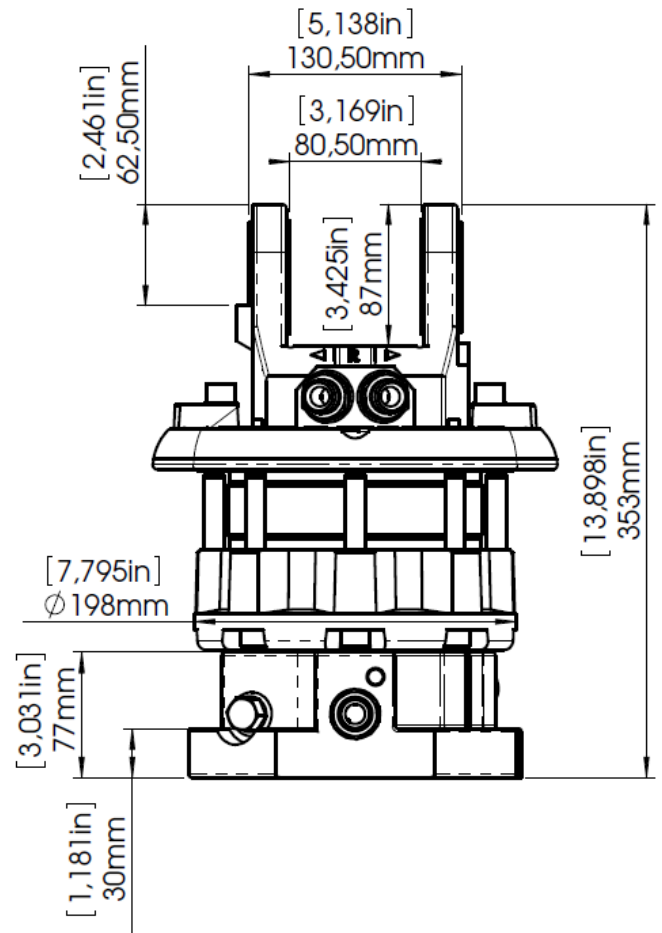
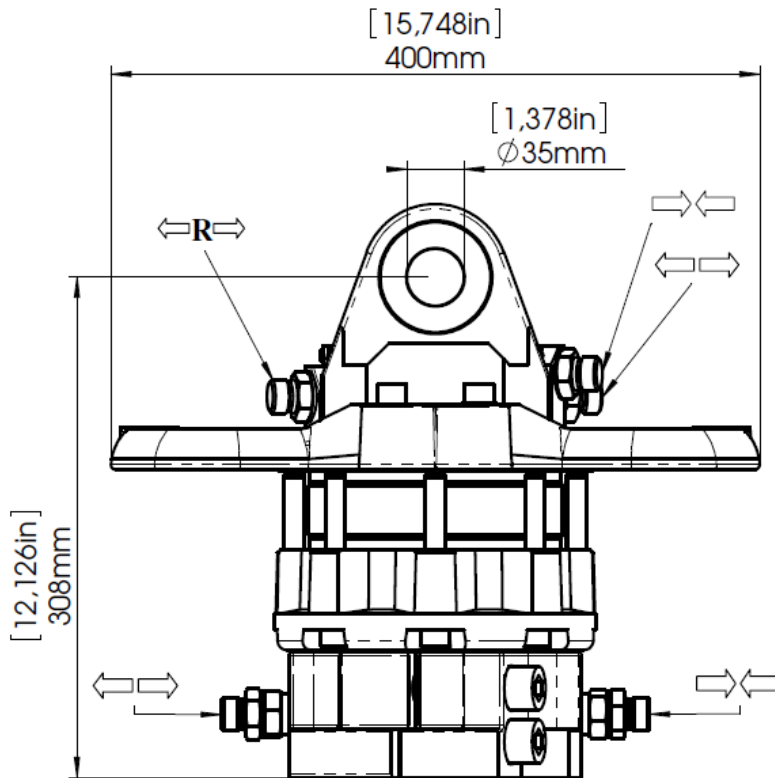

CR 600FX	
Unghi de rotație	nelimitat
Presiunea maximă de lucru:	250 bar
Cilindree:	670 cm ³
Cuplu:	1800 Nm
Forța axială statică:	60 kN
Forța axială dinamică:	30 kN
Greutate:	50 kg