

# Rotator hidraulic CR 500 F173

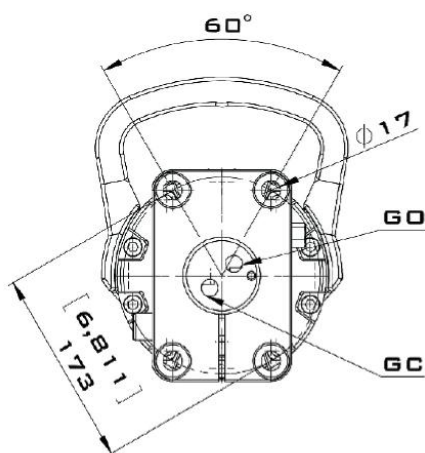
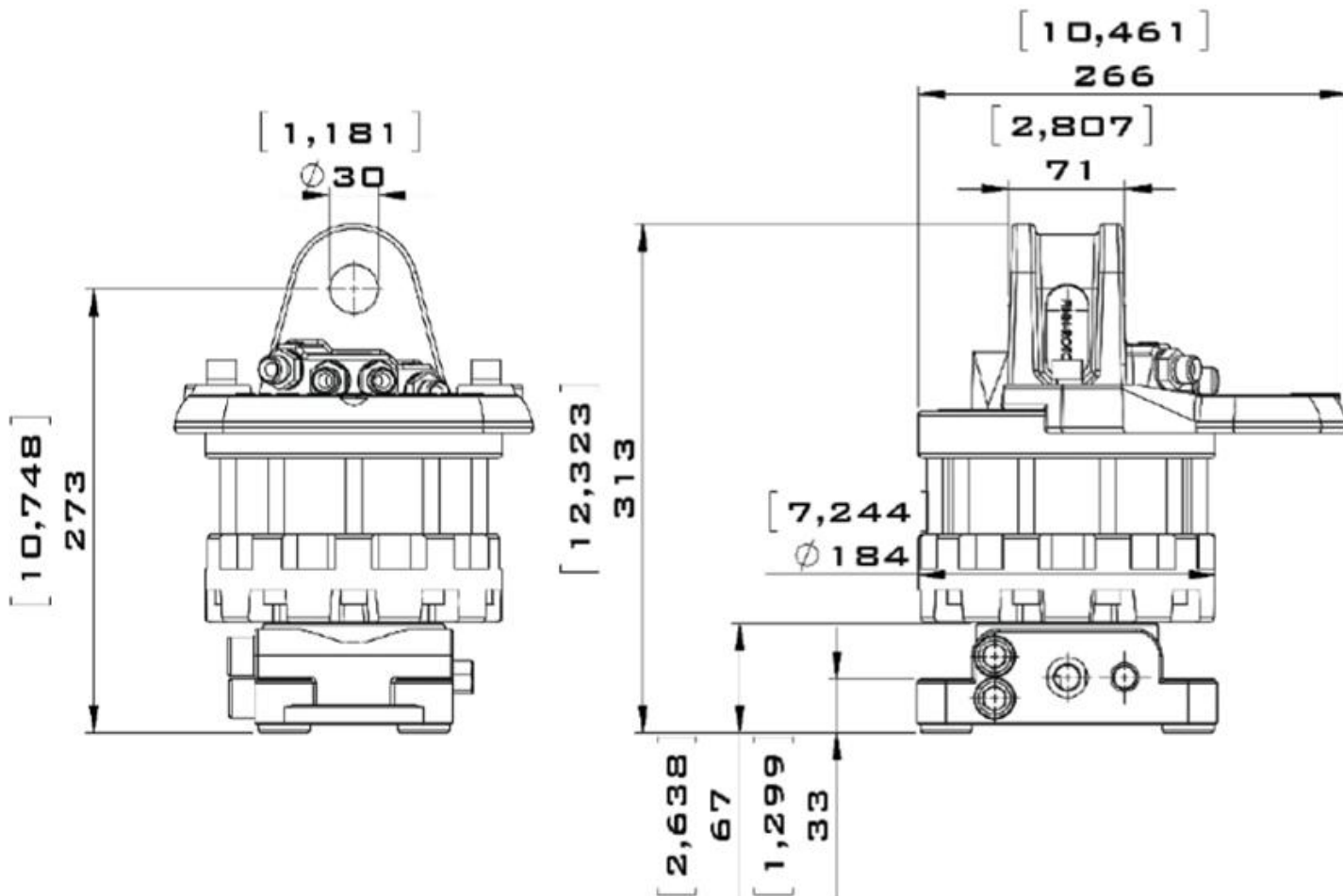

CR 500 F173	
Unghi de rotație	nelimitat
Presiunea maximă de lucru:	250 bar
Cilindree:	465 cm <sup>3</sup>
Cuplu:	1400 Nm
Forța axială statică:	55 kN
Forța axială dinamică:	25 kN
Greutate:	33 kg