

Rotator hidraulic CR 400

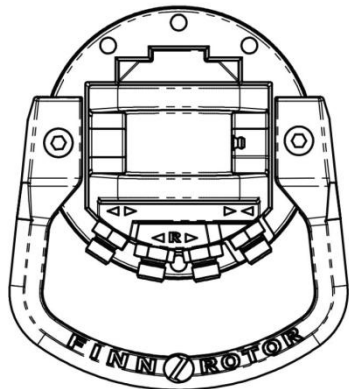
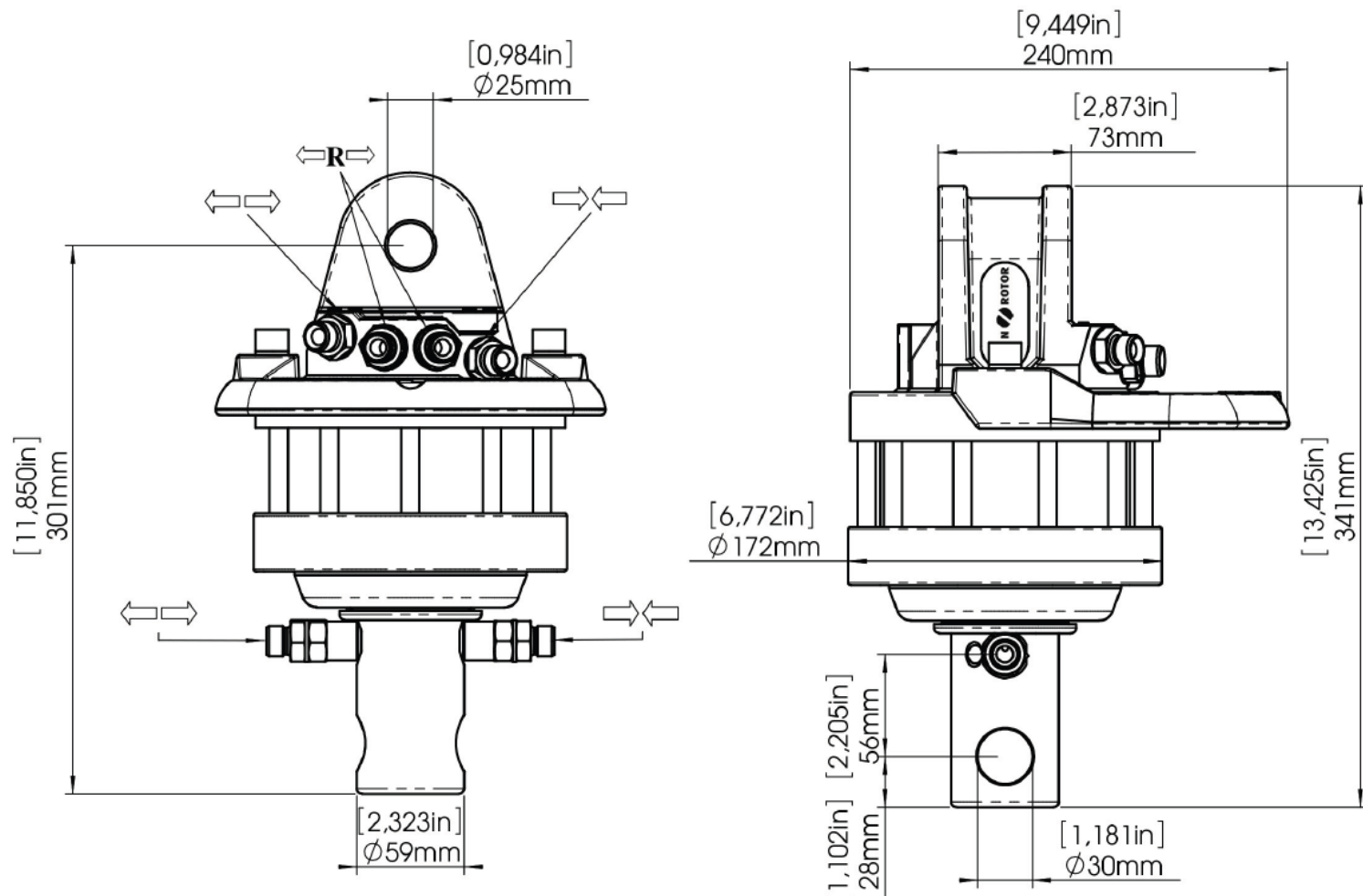

CR 400	
Unghi de rotație	nelimitat
Presiunea maximă de lucru:	250 bar
Cilindree:	420 cm ³
Cuplu:	1100 Nm
Forța axială statică:	40 kN
Forța axială dinamică:	20 kN
Greutate:	23 kg